

YAMAHA

COMBO SYNTHESIZER

CS-50



SERVICE MANUAL

INDEX

	Page
CS-50 Assembly Layout (Top View)	1
CS-50 CORDING GUIDE	
CS-50 SPECIFICATIONS	2
KAS (Key Assigner) Circuit	3
KAS Circuit Board	4
SH (Sample Hold) Circuit	6
SH Circuit Board	7
SUB (Sub Oscillator) Circuit	8
SUB Circuit Board	9
T71 (Tone Preset 1) Circuit	10
T71 Circuit Board	11
T72 (Tone Preset 2) Circuit	12
T72 Circuit Board	13
R7 (Registor) Circuit	14
R7 Circuit Board	15
M (Master) Circuit	16
M ₁ , M ₂ Circuit Board	17
M ₃ , M ₄ Circuit Board	18
PRA (Pre Amp) Circuit	22
PRA Circuit Board	23
KS (Key Switch) Circuit	24
PN ₁ (Pannel 1) Circuit	25
PN ₂ (Pannel 2) Circuit	26
PN ₃ , PN ₅ , PN ₆ , EXP, TS, Circuit	27
Power Supply NP0013Z (Primary) Circuit	29
CS-50 Parts List	



KEY CODER LSI (YM26600)

The LSI detects what keys are held down by judging the pulse combination of the octave and note. It also generates the seven bit key code, which is processed by time sharing, in accordance with the key held down.

- Pin. Pin
- No. Name
- 1. VSS +8.5V Power Supply
- 2. ϕ Master Clock Input
- 3. SC Synchro-clock Output
- 4. SC8 Synchro-clock Output on the first channel.
- 5. IC Initial Clear Input

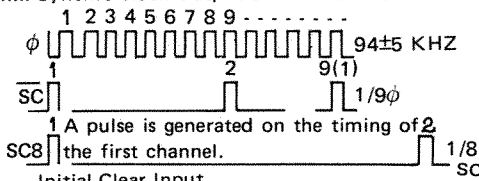

1 A pulse is generated on the timing of 2 the first channel.

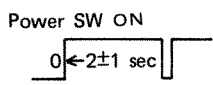

On this timing, C4# code is memoried.

- 6. VDD -6.5V Power Supply Input
- 7. CL } Note on data input
- 8. C# }
- 19. C } When the key is depressed, the pulse is supplied the corresponding pin of the note.

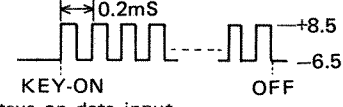

- 20. V1 } Octave on data input
- 24. V5 }
- When the key is depressed, the pulse is supplied to the corresponding pin of the octave.

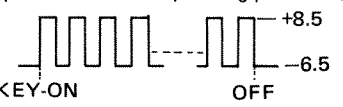

- 25. N1 } Note code data output
 - 28. N4 }
- | | C# | D | D# | E | F | F# | G | G# | A | A# | B | C |
|---|----|---|----|---|---|----|---|----|---|----|---|---|
| N | 1 | 0 | 1 | 1 | 0 | 1 | 1 | 0 | 1 | 1 | 0 | 1 |
| N | 1 | 1 | 0 | 1 | 1 | 0 | 1 | 1 | 0 | 1 | 1 | 0 |
| N | 1 | 1 | 1 | 0 | 0 | 0 | 1 | 1 | 1 | 0 | 0 | 0 |
| N | 1 | 1 | 1 | 1 | 1 | 1 | 0 | 0 | 0 | 0 | 0 | 0 |

- 29. B1 } Octave Code Data Output
 - 31. B3 }
- | | C2 | C2#~C3 | C3#~C4 | C4#~C5 | C5#~C6 |
|----|----|--------|--------|--------|--------|
| B1 | 0 | 1 | 0 | 1 | 0 |
| B2 | 1 | 0 | 0 | 1 | 1 |
| B3 | 1 | 1 | 1 | 0 | 0 |

- 32. KO1 } Key on Data Output
 - 39. KO8 }
-

The number of note sounded is variable by using this pin.
 i.e.) Up to 4 notes: Supply -6.5V to KO5.
 Up to 3 notes: Supply -6.5V to KO4.

- 40. Mode Switching output for sound model
 For 8 notes Supply -6.5V (1)
 For 7 notes Supply +8.5V (0)

KEY ASSIGNER & D-A CONVERTER LSI (YM26700)

The time shared key data is supplied to the LSI. Analog DC voltage is produced in corporation with key by the data and supplied to each channel.

- 1. VSS +8.5V Power Supply
- 2. SC8 Synchro-clock input on the first channel.
- 3. POR Portamento and Glissando operation. When the portamento VR is turned on, +8.5V is supplied to the pin and actuate.
- 4. PC Clock input for Portamento and Glissando operation.

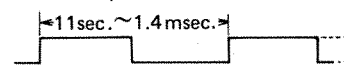

The frequency is variable by changing the portamento VR.

- 5. N1 } Note code data input
- 8. N4 }
- 9. B1 } Octave code data input
- 11. B3 }
- 12. OO Output for octave key voltage. (8ch time sharing)
 Provided the output key voltage for the octave selected from octave code.
- 13. OCT0 } Input for octave key voltage.
- 18. OCT5 }
- * TU pin: 4.0V

	OCT0	OCT1	OCT2	OCT3	OCT4	OCT5
Voltage	0.25V	0.5V	1.0V	2.0V	4.0V	4.0V

The voltage of TU line is divided by the ladder composed resistors and supplied to each pin constantly.

- 19. C# } Input for note key voltage
- 30. C }

OO pin: 4.0V

	C#	D	D#	E	F	F#
Voltage	2.119	2.245	2.378	2.520	2.670	2.828

	G	G#	A	A#	B	C
Voltage	2.997	3.175	3.364	3.564	3.775	4.0V

The voltage of OO line is divided by the ladder composed resistors and supplied to each pin constantly.

- 31. CH8 } Key voltage output
- 38. CH1 }
- The output of voltage determined by each key is provided in accordance with the channel key code.
- 39. VDD -6.5V Power Supply, Input
- 40. ϕ Master Clock Input f=94±5KHz

SH (Sample Hold) Circuit

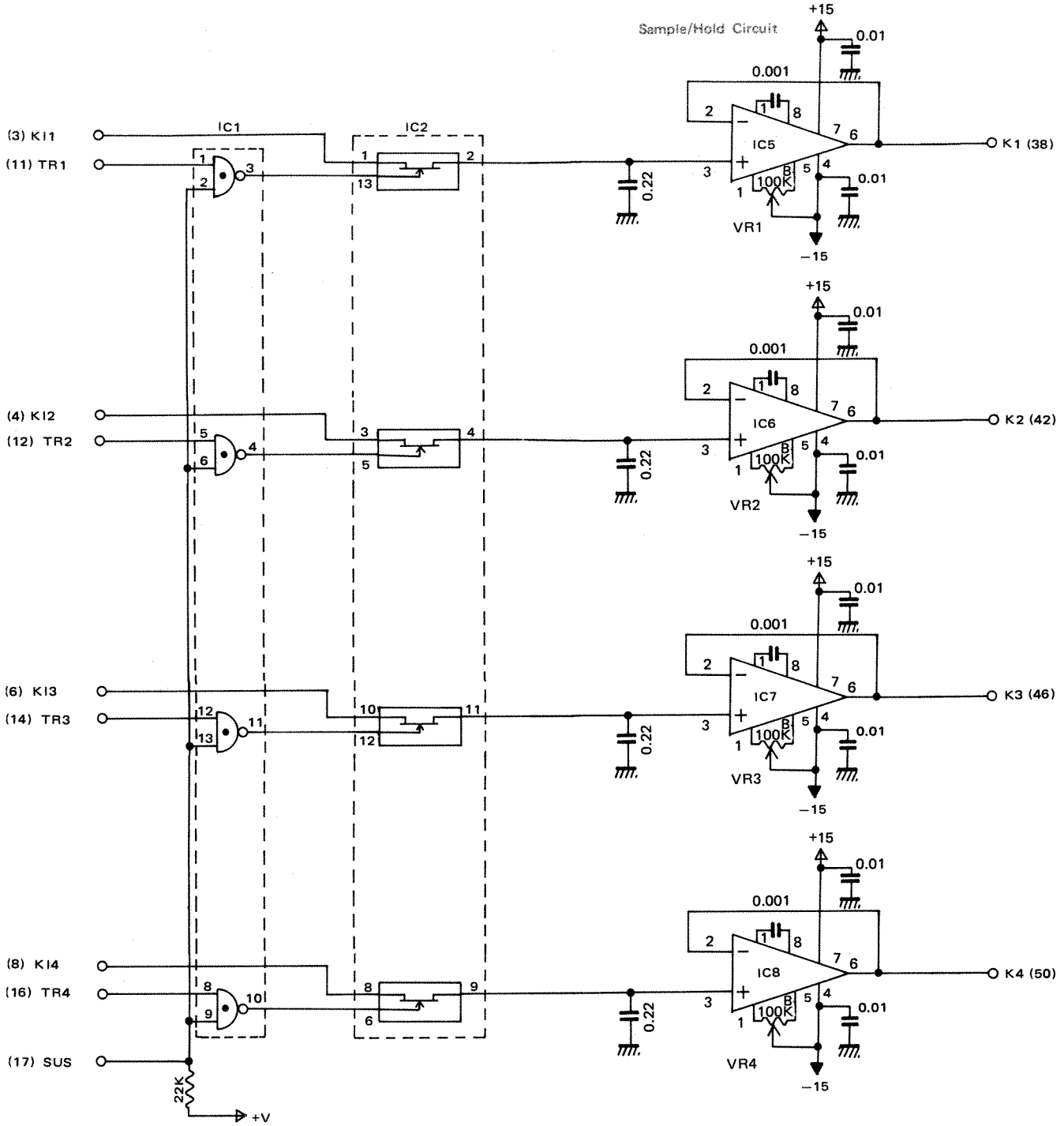

Note)

1. IC1,3 : TC4011P
 IC2,4 : TC4016P
 Power Supply of IC
 7 Pin -V
 14 Pin +V
2. Capacitor
 0.1 Ceramic Capacitor
 0.22 ... Mylar Capacitor
 47/16... Electrolytic Capacitor

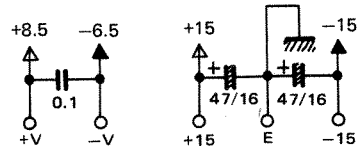

R7 (Register) Circuit

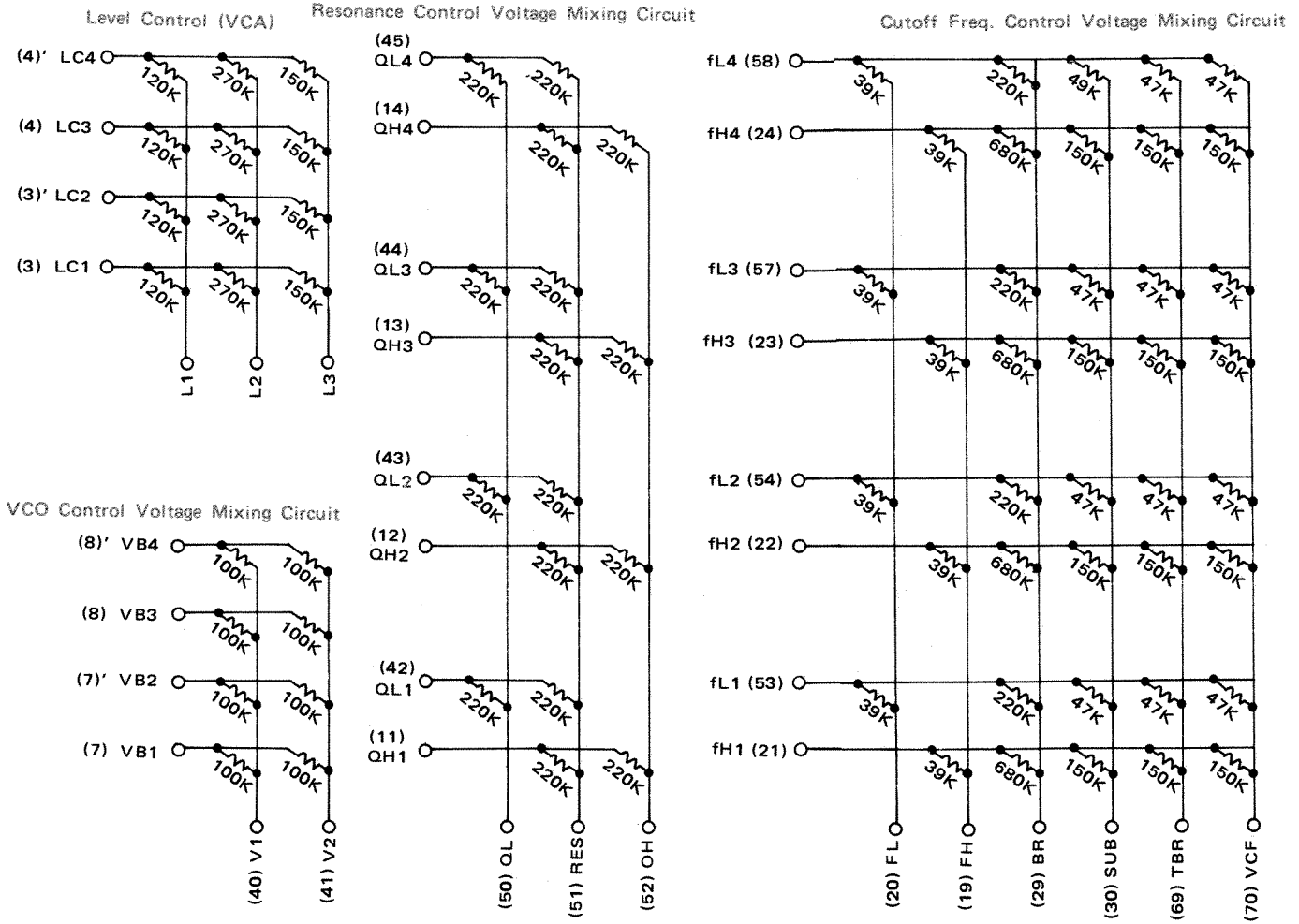

VCO III IC (IG00153)

This IC is used for voltage controlled oscillator. Many different frequencies are produced by the voltage supplied.

- 1. FT Resistor for determination of the feet. The electric current is provided to the pin from transposition changing circuit so that the octave can be determined.
- 2. KV Input of the key voltage
The input of the voltage is provided to the pin in corporation with the keys held down.

High voltage High frequency
Low voltage Low frequency

Input Voltage	Output Frequency
0.250V	130.8Hz (C2)
0.500V	261.6Hz (C3)
1.000V	523.2Hz (C4)
2.000V	1046.0Hz (C5)
4.000V	2093.0Hz (C6)

Transposition "normal"

- 3. } OFF-SET Zero adjustment of input
- 4. } buffer circuit
- 5. Vee -15V input power source.
- 6. Com Phase compensation for input buffer amplifier.
Normally, the output (KV + 1V) is supplied to the pin.
- 7. OUT Output

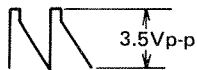

Asto the frequency, refer to the Pin No.2 (KV).

- 8. GND Earth
- 9. Vref Input of the standard voltage.
- 10. CT Circuit for time constant.

The following wave shape is produced.

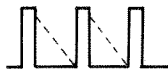

- 11. RT Circuit for time constant.

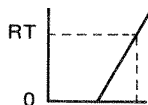

Determines the discharging voltage level.

- 12. T1 Input for the comparator.
Input of the wave shape (N) is provided. from the pin no. 14 (TO).

- 14. TO Output from time constant circuit.
The following wave shape is produced.

- 15. VIB Input for vibrato control wave.
Input of the control wave is provided by VCO lever of SUB-OSC.

- 16. Vcc +15V input power source.

VCF IC (IG00156)

- 1. AI Signal Input
Input signals from VCO and WSC are provided to this pin.
- 2. KV Key voltage input
In order to change the tone color according to the tone range of keyboard, the designated voltage of the key will supplied to the pin. (0.25-4.0V)
- 3. fc Adjustment of the cut off frequency.
Set the control currency of the cut off frequency.
- 4. Vf Input of the cut off voltage.
Input voltage of cut off frequency is supplied to this pin so that the tone color can be changed. The center point of the cut off frequency can be also set.
When the VK is 0.25V and Vf is 5V, the cut off frequency is set to just 1KMz.
- 5. Vcc +15V input power source
- 6. Q0 Q adjustment.
The Q control current sets the Q equal to 5, when Vq is 0 volt.

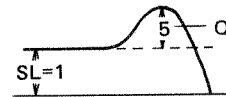

- 7. Vq Input of the voltage for Q control.
Q is variable according to the control voltage supplied.
When the control voltage is 0V (Max.), Q=5
When the control voltage is 10V (Min.), Q=0.5

- 8. GND Earth
- 9. FB Q feed back
This is the feed back output pin for the Q control by which the Q is determined.

- 10. LP Low-pass output

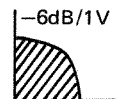

The output of lower frequencies are produced.

- 11. C2 C pin for determination of the cut off frequency.

- 12. Vee -15V power source.

- 13. BP Band-pass output.



The output of intermediate frequencies are produced.

- 14. C1 C pin for determination of the cut off frequency.

- 15. HP Hi-pass output



The output of higher frequencies are produced.

- 16. IN In]ut of feed back
The input signal for determination of cut off frequency.

VCF-EG IC (IG00152)

This IC generates envelope wave shape which is supplied to VCF and control the tone color.

- 1. NC Not connected
- 2. BI Input of buffer amplifier.
- 3. OUT Output of buffer amplifier.

The buffer amplifier is built in for the purpose of matching impedance.

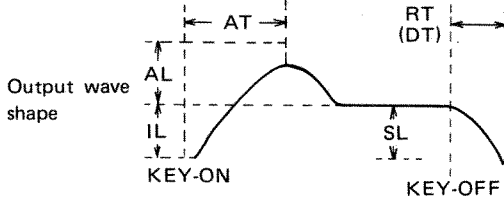

- 4. GND Earth
- 5. Vcc +15V input power source.
- 6. G1 Gate 1
- 7. G2 Gate 2

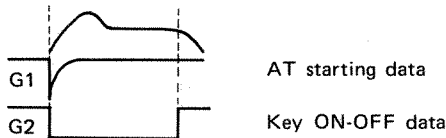

- 8. Vee -15V input power source.
- 9. AT Input of buffer voltage for determination of the attack time. Input of the voltage between zero V and 10V is provided and the attack time is controlled from 1 mS until 1S.

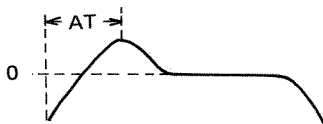

- 10. 1DT Input of buffer voltage for determination of the decay time. Input of the voltage between zero V and 10V is provided and the first decay time is controlled from 10mS until 10 S.

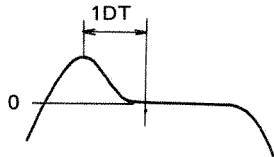

- 11. 2DT Input of buffer voltage for determination of the release time. Input of the voltage between zero V to 10V is provided and the time from KEY-ON until release is controlled from 10m second until 10 second.

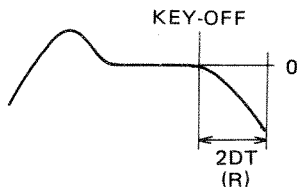

- 12. TC Output of the time control. Output of DC voltage is produced so that the each time of attack, 1DT and 2DT are controlled.

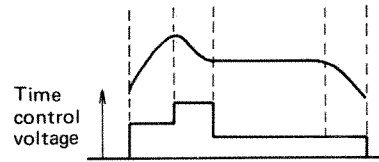

The higher the voltage, the shorter the time and the lower the voltage the longer the time.

- 13. LC Output of level control.

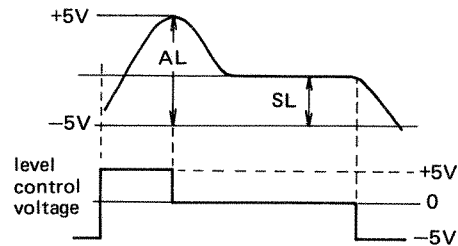

The higher the voltage, the higher the level and the lower the voltage the lower the level.

- 15. SL Input of buffer voltage for determination of the sustain level.

Normally fixed to zero(0) volt.

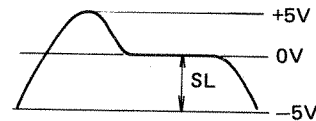

- 16. IL Input of buffer voltage for determination of the initial level. Input of the voltage between zero (0) and ten (10) is provided and the initial level is controlled from zero to minus 5 volt.

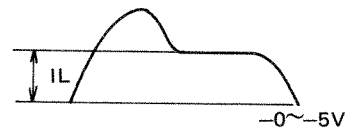

YAMAHA

COMBO SYNTHESIZER

CS-50

Parts List



CONTENTS

Circuit Boards & Components (シート及びシート部品).....	1
Power Supply (電源)	5
Key Board & Panel Component (鍵盤及びパネル)	7
Cabinet (外装部品).....	10
EXP.	12



,



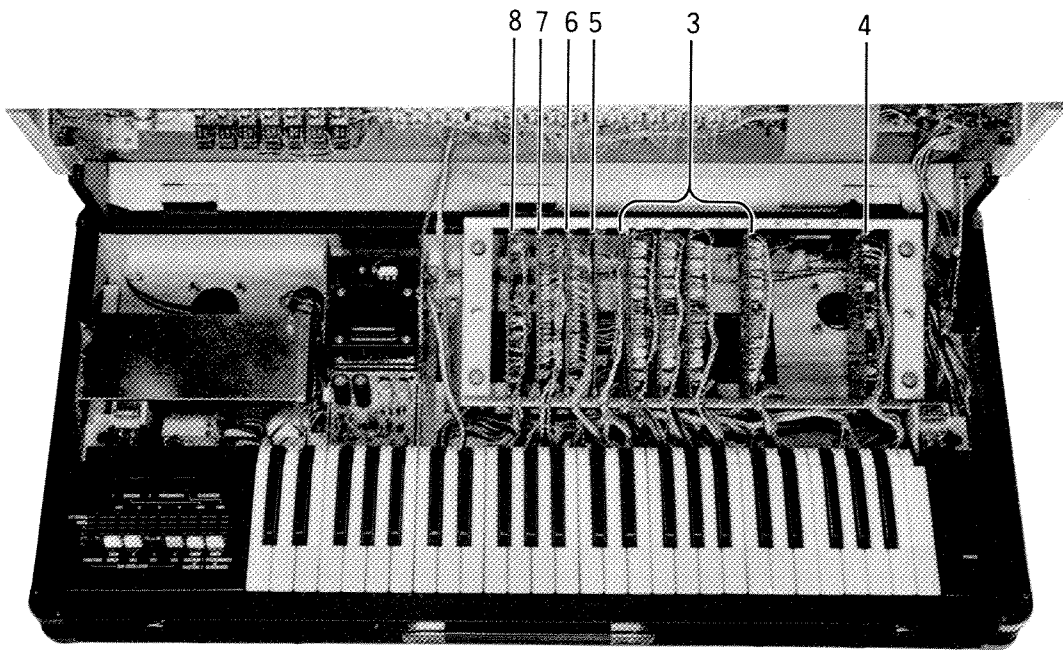
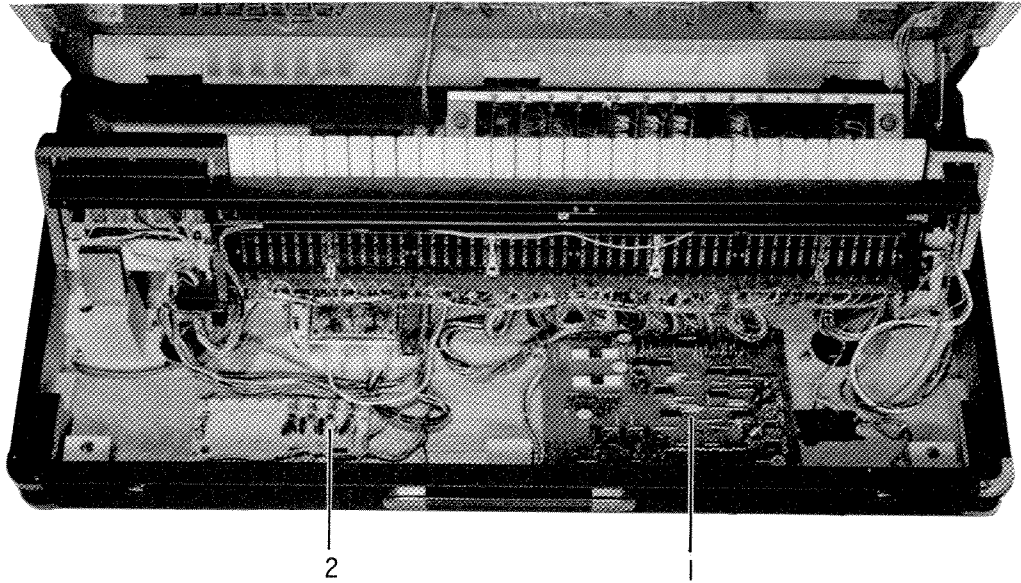

Ref. No.	Part No.	Description	Remarks	Common Models
1	30 12 50 NA 03 65 00	KAS Circuit Board #21264	KAS シート	
2	30 12 50 NA 03 79 20	SH --do.-- #22542	SH シート	
3	30 12 50 NA 04 48 50	M --do.-- #21233	M シート	CS-60
4	30 12 50 NA 04 48 60	PRA --do.-- #41383	PRA シート	
5	30 12 50 NA 04 48 10	SUB --do.-- #41336	SUB シート	
6	30 12 50 NA 04 48 40	R ₇ --do.-- #41361	R ₇ シート	
7	30 12 50 NA 04 47 20	T71 --do.-- #21183	T71 シート	
	30 12 50 NA 04 48 30	T72 --do.-- #41352	T72 シート	
	30 10 00 YM 26 60 00	LSI YM26600	L S I	
	30 10 00 YM 26 70 00	--do.-- YM26700	L S I	
	40 10 00 i G 00 10 40	Integrated circuit TA7504M	"	
	40 10 00 i G 00 12 10	--do.-- LM310	I C	
	40 10 00 i G 00 12 40	--do.-- TC4011P	"	
	40 10 00 i G 00 12 60	--do.-- TC4069P	"	
	40 10 00 i G 00 13 90	--do.-- NJM4558D	"	
	40 10 00 i G 00 14 10	--do.-- BA617	"	
	40 10 00 i G 00 15 00	--do.-- IG00150	"	VCOII
	40 10 00 i G 00 15 10	--do.-- IG00151	"	VCA
	40 10 00 i G 00 15 20	--do.-- IG00152	"	EG-VCF
	40 10 00 i G 00 15 30	--do.-- IG00153	"	VCOIII
	40 10 00 i G 00 15 60	--do.-- IG00156	"	VCF
	40 10 00 i G 00 15 80	--do.-- IG00158	"	WSC
	40 10 00 i G 00 15 90	--do.-- IG00159	"	EG-VCA
	40 10 00 i G 00 16 20	--do.-- MA796HC	"	
	40 10 00 i G 00 16 90	--do.-- TC4016P	"	
	40 10 00 i G 00 17 90	--do.-- TC4050P	"	
	40 10 00 i G 00 22 20	--do.-- CA3140T	"	
	40 10 00 i A 04 90 20	Transistor 2SA490	トランジスタ	
	40 10 00 i A 05 61 70	--do.-- 2SA561	"	
	40 10 00 i C 04 58 80	--do.-- 2SC458	"	
	40 10 00 i D 02 34 30	--do.-- 2SD234	"	
	40 10 00 i E 00 00 10	FET 2SK30	F E T	
	40 10 00 i F 00 00 40	Diode 1S1555	ダイオード	
	40 10 00 i F 00 03 00	--do.-- 1S1715P	"	
	40 10 00 i F 00 04 20	Zener diode 02Z5.6A	ツェナー	
	40 10 00 HU 36 53 00	Metal film resistor 2% 300Ω	金属被膜抵抗	
	40 10 00 HU 36 53 30	--do.-- --do.--330Ω	"	
	40 10 00 HU 36 57 50	--do.-- --do.--750Ω	"	
	40 10 00 HU 36 68 20	--do.-- --do.--8.2KΩ	"	
	40 10 00 HU 36 71 00	--do.-- --do.--10KΩ	"	

Ref. No.	Part No.	Description	Remarks	Common Models
40:10:00	HU 36 71 80	Metal film resistor 2% 18K Ω	金属被膜抵抗	
40:10:00	HU 36 72 20	-do.- -do.-22K Ω	"	
40:10:00	HU 57 61 80	-do.- 1%-1.8K Ω	"	
40:10:00	HU 57 72 20	-do.- -do.-22K Ω	"	
40:10:00	HU 57 81 50	-do.- -do.-150K Ω	"	
40:10:00	HU 19 72 00	-do.- 0.1% 20K Ω	"	
40:10:00	HU 19 74 00	-do.- -do.-40K Ω	"	
40:10:00	HU 19 78 00	-do.- -do.-80K Ω	"	
40:10:00	HU 19 81 60	-do.- -do.-160K Ω	"	
40:10:00	HU 59 51 00	-do.- 0.01%100 Ω	"	
40:10:00	HU 59 61 00	-do.- -do.-1K Ω	"	
40:10:00	HU 59 62 00	-do.- -do.-2K Ω	"	
40:10:00	HZ 00 08 60	-do.- -do.-29.94K Ω	"	
40:10:00	Hi 30 93 30	Solid resistor 3.3M Ω	ソリッド抵抗	
40:10:00	Hi 20 94 70	-do.- 4.7M Ω	"	
40:10:00	Hi 20 99 90	-do.- 10M Ω	"	
40:10:00	HL 32 42 20	Metal oxide film resistor 2W 22 Ω	酸化金属被膜抵抗	
40:10:00	FF 04 31 20	Polystyrene capacitor 1200pF	スチロールコンデンサ	
40:10:00	FP 13 72 20	Tantalum capacitor 16V 22 μ F	タンタル	
40:10:00	FM 09 71 00	Non polar capacitor 16V 10 μ F	NP コンデンサ	
40:10:00	FM 22 71 00	-do.- 25V 10 μ F	"	
40:10:00	FM 22 73 00	-do.- 25V 33 μ F	"	
40:10:00	FM 11 61 00	-do.- 50V 1 μ F	"	
40:10:00	FM 11 64 00	-do.- 50V 4.7 μ F	"	
40:10:00	HT 55 00 60	Semi variable resistor 3006 typeB-5K Ω	半固定抵抗	
40:10:00	HT 56 01 50	-do.- 3321HType B-20 Ω	"	
40:10:00	HT 56 00 00	-do.- -do.-B-50 Ω	"	
40:10:00	HT 56 00 20	-do.- -do.-B-200 Ω	"	
40:10:00	HT 56 00 70	-do.- -do.-B-10K Ω	"	
40:10:00	HT 56 01 00	-do.- -do.-B-100K Ω	"	
40:10:00	HT 12 00 10	-do.- V10K4TypeB-1K Ω	"	
40:10:00	HT 12 00 80	-do.- -do.-B-2K Ω	"	
40:10:00	HT 12 00 20	-do.- -do.-B-5K Ω	"	
40:10:00	HT 12 00 50	-do.- -do.-B-50K Ω	"	
40:10:00	HT 12 00 70	-do.- -do.-B-	"	
40:10:00	HT 12 00 60	-do.- -do.-B-500K Ω	"	
40:10:00	HT 12 01 10	-do.- -do.-B-1M Ω	"	

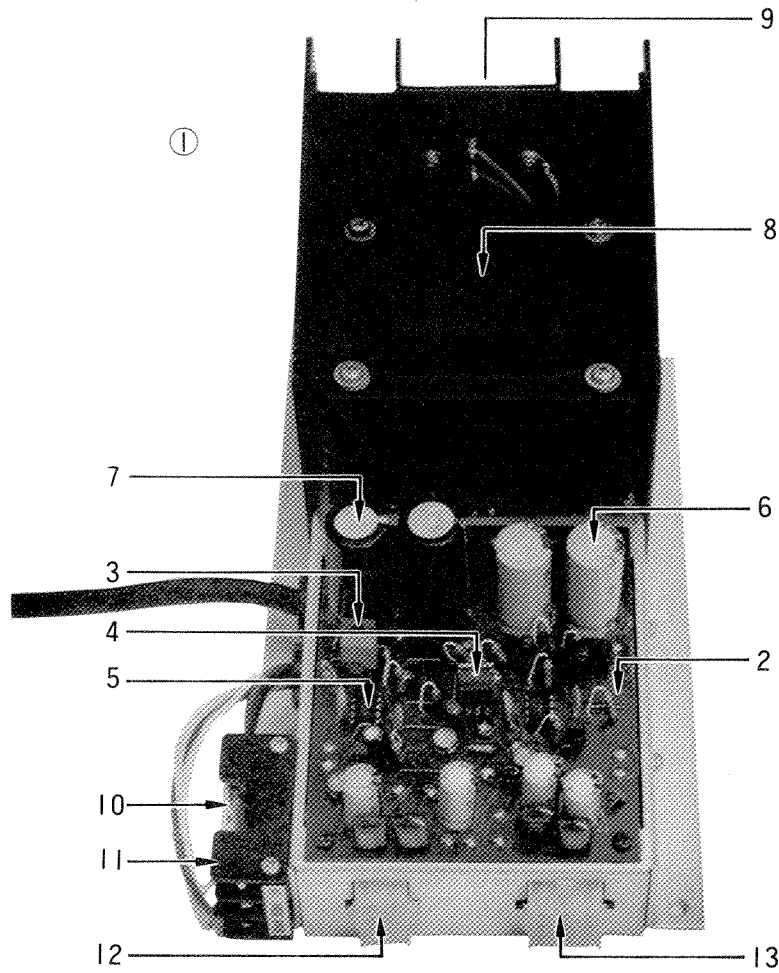

Ref. No.	Part No.	Description	Remarks	Common Models
1	30:12:00 NP:00:13:00	Power Supply Unit	電源ユニット	BS
	30:12:00 NP:00:13:10	-do.-	"	国内
	30:12:00 NP:00:13:20	-do.-	"	General
	30:12:00 NP:00:13:30	-do.-	"	UL
	30:12:00 NP:00:13:40	-do.-	"	South African
	30:12:00 NP:00:13:50	-do.-	"	Australian
	30:12:00 NP:00:13:60	-do.-	"	European, North European
	30:12:00 NP:00:13:80	-do.-	"	CSA
2	30:12:00 NA:03:55:90	SVU Circuit board #20922	SVU シート	
3	40:10:00 iA:04:90:20	Transistor 2SA490	トランジスタ	
	40:10:00 iA:05:61:70	-do.- 2SA561	"	
	40:10:00 iC:08:28:80	-do.- 2SC828	"	
4	40:10:00 iD:02:34:10	-do.- 2SD234	"	
	40:10:00 iF:00:00:40	Diode 1S1555	ダイオード	
	40:10:00 iH:00:01:40	-do.- 10DC-4	"	
	40:10:00 iH:00:01:50	-do.- 10DC-4R	"	
	40:10:00 iF:00:01:00	Zener diode 1S1715	ツェナー	
	40:10:00 iF:00:07:80	-do.- WZ150	"	

Ref. No.	Part No.	Description	Remarks	Common Models
5	40 10 00 i G 00 13 90	Integrated circuit RC4558	I C	
	40 10 00 HL 31 24 70	Metal oxide resistor 1P0.47Ω	酸金抵抗	
6	40 10 00 FJ 14 91 00	capacitor 25V 1000μF	コンデンサ	
7	40 10 00 FJ 25 92 20	--do.-- 35V 2200μF	"	
8	40 10 00 GA 02 86 10	Power transtermer	電源トランス	
	40 10 00 i A 04 90 10	Transistor 2SA490	トランジスタ	
	40 10 00 i A 07 45 00	--do.-- 2SA745	"	
9	40 10 00 i D 02 03 00	--do.-- 2SD203	"	
	40 10 00 i D 02 34 10	--do.-- 2SD234	"	
	40 10 00 FZ 00 01 10	Sperk Killer 125V0.33μF + 120Ω	CR 複合部品	UL spec
	40 10 00 FZ 00 09 50	--do.-- 250V --do.--	"	CSA spec
	40 10 00 HM 52 24 70	Cement molded resistor 2W 0.47Ω	セメント抵抗	
	40 10 00 FQ 02 44 70	Oil capacitor 630V 0.047μF	オイルコンデンサ	
10	40 10 00 KB 00 04 30	Fuse 1.25A	ヒューズ	国内
	40 10 00 KB 00 03 10	--do.-- 0.5A	"	
	40 10 00 KB 00 07 10	--do.-- miniature Type 0.5A	"	BS, European, North European spec
	40 10 00 KB 00 06 60	--do.-- --do.-- 0.4A	"	BS spec
	40 10 00 KB 00 11 50	--do.-- Approved by UL 0.5A	"	UL, CSA spec
	40 10 00 KB 00 14 50	--do.-- --do.-- 1.25A	"	--do.--
11	40 10 00 LB 20 10 80	Fuse holder Block Type	ヒューズホルダー	BS, European, North European spec
	40 10 00 LB 20 10 90	--do.-- --do.--	"	
12	40 10 00 LB 60 15 30	Connector 6 pin	コネクタ 6 P	
13	40 10 00 LB 60 15 40	--do.-- 9 pin	" 9 P	

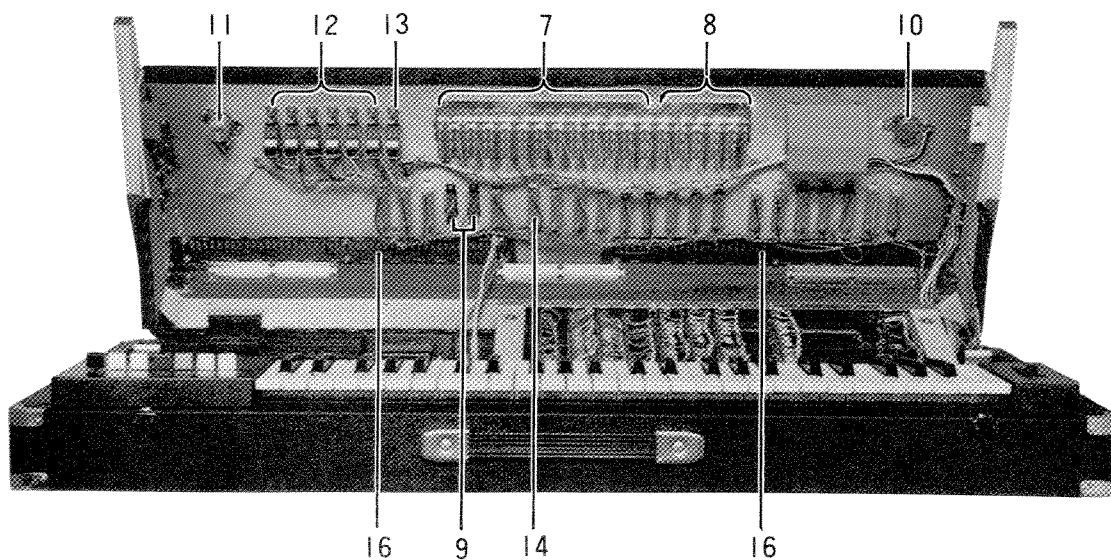
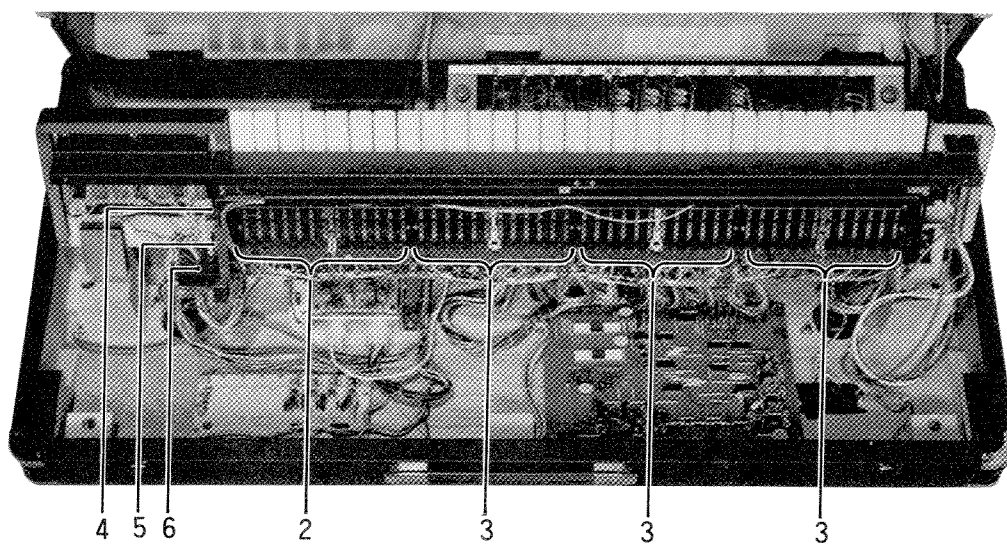
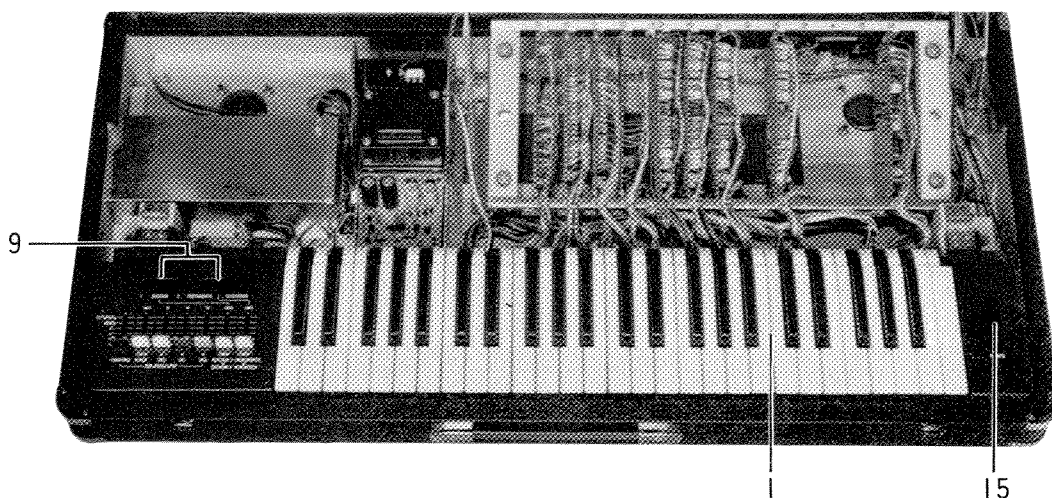

Ref. No.	Part No.	Description	Remarks	Common Models
1	30 12 50 NB 04 51 50	Key board assembly	鍵盤 A'ssy	
2	30 10 00 NB 04 51 60	Switch assembly 1U #4085	スイッチA'ssy	13Keys
3	30 10 00 NB 04 51 70	--do.-- 2・3・4 U #4086	"	12Keys
	30 10 00 CB 01 11 70	White Key C.F	白 鍵	
	30 10 00 CB 01 11 80	--do.-- D	"	
	30 10 00 CB 01 11 90	--do.-- E.B	"	
	30 10 00 CB 01 12 00	--do.-- G	"	
	30 10 00 CB 01 12 10	--do.-- A	"	
	30 10 00 CB 01 12 20	--do.-- C'	"	
	30 10 00 CB 01 12 30	Black Key	黒 鍵	
	30 10 00 AA 01 56 70	Key spring for White Key	キースプリング	
	30 10 00 AA 01 56 80	--do.-- for Black Key	"	
4	30 10 00 AA 03 24 40	Plate for Shatter	シャッター取付板	
5	30 10 00 BC 00 27 90	Shatter Plate	シャッター板	
6	30 10 00 NB 03 41 10	Touch Control pick-up assembly	T・Cピックアップ A'ssy	
	30 10 00 CB 01 86 40	Dust cover	ダストカバー	
	30 10 00 CB 02 86 00	Kno White	ツ マ ミ 白	
	30 10 00 CB 02 86 10	--do.-- Black	" 黒	
	30 10 00 CB 02 86 20	--do.-- Red	" 赤	
	30 10 00 CB 02 86 30	--do.-- Green	" 緑	
	30 10 00 CB 02 86 40	--do.-- Yellow	" 黄	
	30 10 00 CB 02 86 50	--do.-- Gray	" 灰	
	30 10 00 CB 02 86 60	--do.-- Black	" 黒	for Volume
	30 10 00 CB 02 86 70	TVR Knob White	" 白	
	30 10 00 CB 02 86 80	--do.-- Black	" 黒	
	30 10 00 CB 02 86 90	--do.-- Red	" 赤	
	30 10 00 CB 02 87 00	--do.-- Green	" 緑	
	30 10 00 CB 02 87 10	--do.-- Gray	" 灰	
	30 10 00 CB 03 01 20	Knob Black (out side)	" (外側)	for pitch
	30 10 00 CB 03 01 30	--dn.-- --do.-- (inside)	" (内側)	--do.--
7	40 10 00 KA 90 04 20	Push switch 14channel	プッシュ S W	for Tone Selector
8	40 10 00 KA 90 04 30	--do.-- 4 channel	"	for Transposition
9	40 10 00 KA 10 00 90	See saw switch	シーソー S W	
10	40 10 00 HR 20 00 20	Variable vesistor A-10K Ω	ボリウム	for Volume
11	40 10 00 HR 60 00 20	--do.-- B-10K Ω +B-500 Ω	"	for Pitch

Ref. No.	Part No.	Description	Remarks	Common Models
12	40:10:00:HP:70:00:10	TVR B-10KΩ	T V R	
13	40:10:00:HP:70:00:20	-do.- B-10KΩ	"	for Brilliance
14	40:10:00:HQ:30:00:10	Slide variable resistor B-10KΩ	スライド V R	
	40:10:00:HQ:30:03:20	-do.- C-10KΩ	"	for Sustain
	30:10:00:AA:03:67:70	Back Panel	バックパネル	General, South African models
	30:10:00:AA:03:67:80	-do.-	"	国内,UL,CSA,BS, Australian models
	30:10:00:AA:03:70:20	-do.-	"	North European, European models
	40:10:00:LB:20:04:80	Holder for fuse	ヒューズホルダー	General, South African models
	40:10:00:LB:20:05:90	-do.-	"	North European, European models
	30:10:00:CB:01:91:30	Knob EXTERNAL-LEVEL	つまみ	
	40:10:00:HR:20:01:90	Variable resistor -do.-	ポリューム	
	40:10:00:LB:20:02:50	Voltage Selector	電圧切替器	
	40:10:00:KA:40:00:00	Slide Switch High↔Low	スライド S W	
	40:10:00:LB:20:06:30	Phone jack Output	ヘッドフォンジャック	
	40:10:00:LB:40:01:00	-do.- Foot controller	"	
15	40:10:00:KA:10:00:60	Power switch	パワー S W	国内
	40:10:00:KA:10:00:70	-do.-	"	
	40:10:00:KA:10:03:40	-do.-	"	European, North European, BS models
	40:10:00:JB:00:01:80	Neon lamp	ネオン管	European, North European, BS models
	30:54:00:CB:00:16:60	Pilot lens, red	赤玉	-do.-
	30:10:00:CB:00:77:70	Lamp holder	ランプホルダー	-do.-
16	30:10:00:AA:04:01:70	Grille for radiator	放熱グリル	

4. Cabinet (外装部品)

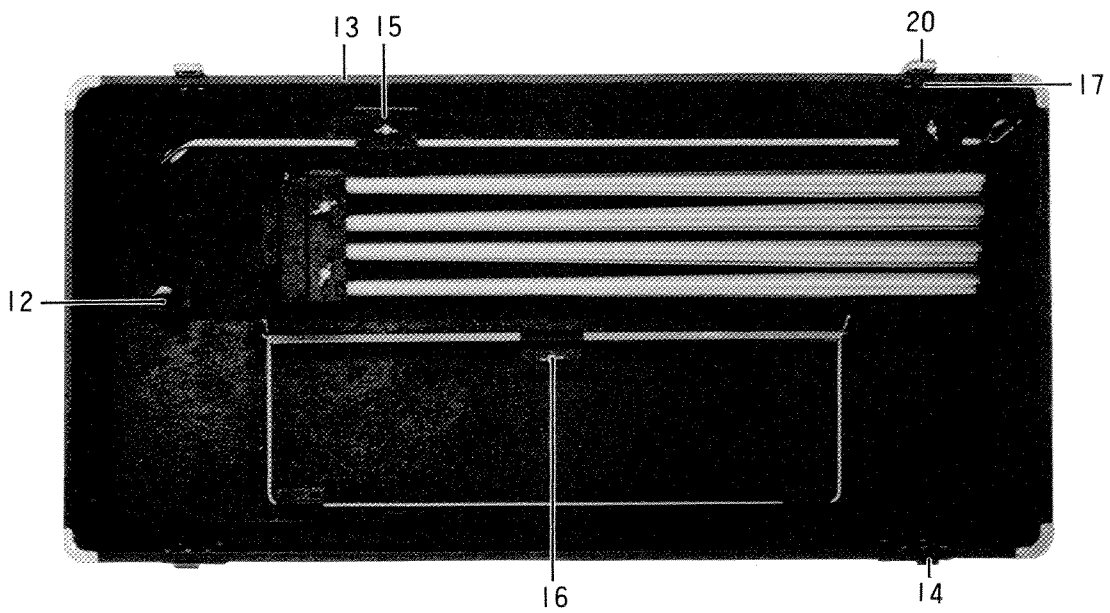
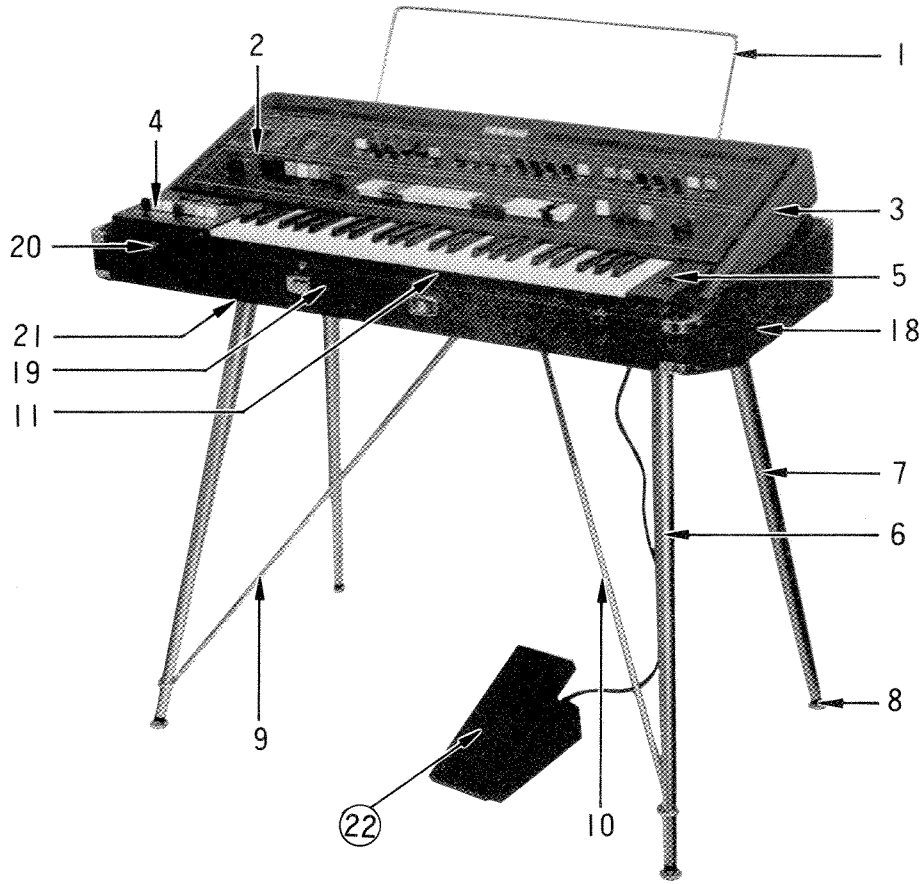

Ref. No.	Part No.	Description	Remarks	Common Models
1	30 10 00 AA 03 69 70	Music rest	譜面台	
2	30 12 50 00 04 45 10	Control panel	コンパネ	
	30 13 00 AA 01 65 00	Stay for control panel	ステー	
3	30 12 50 00 05 55 00	Side panel	パネル側板	
	30 10 00 AA 03 68 40	Bush for music rest	譜面台ブッシュ	
4	30 12 50 00 04 55 10	End block Left	拍子木(左)	
5	DA 01 74 20	-do.- Right	" (右)	
	NK 00 27 30	-do.- -do.-	" (右)	North European, BS, European models
6	30 10 00 NB 00 78 40	Leg Assembly Long	脚柱	
7	30 10 00 NB 04 53 40	-do.- Short	"	
8	30 10 00 NB 00 78 50	Chair Grades	脚台	
9	30 10 00 AA 03 69 00	Stay Left	支柱(左)	
10	30 10 00 AA 03 69 10	-do.- Right	" (右)	
12	40 10 00 EK 00 32 10	Knob bolt for Stay stopper	ノブボルト	6×30
11	30 10 00 AA 03 67 40	Key board spacer	鍵盤金	
13	30 12 50 00 02 13 00	External cover	ケース蓋	
14	30 10 00 AA 96 09 00	Hinge Stopper	引掛け丁番	
15	40 10 00 EV 75 01 50	Wing bolt	蝶ネジ	M5×15
16	40 10 00 EV 76 01 50	-do.-	"	M6×15
17	40 10 00 CB 01 06 40	P Nut	P ナット	
	40 10 00 EA 03 01 00	Pan head screw	ナベ小ネジ	3×10 ZMCZ
17	30 10 00 BB 00 18 90	Nut	特殊ナット	
18	30 12 50 00 04 07 00	Cabinet	本体ケース	
19	30 10 00 NB 80 29 00	Handle assembly	取手A'ssy	
20	30 10 00 AA 96 08 80	Lock	バッチン錠	
21	30 10 00 AA 01 39 20	Flange, leg	脚フランジ	
	40 10 00 EA 05 02 50	Pan head screw	ナベ小ネジ	5×25
	40 10 00 EV 10 00 50	Hexagonal nut	六角ナット	5 ZMCZ-Y
	40 10 00 EW 20 00 50	Flain washer	平座金	5
	30 54 00 AA 80 18 50	Grille radiator	放熱グリル	
	30 10 00 AA 03 68 40	Bush Music rest	譜面台ブッシュ	
	30 12 50 00 04 07 10	Lid AC cord	コード収納蓋	

